

INPUT CONNECTORS

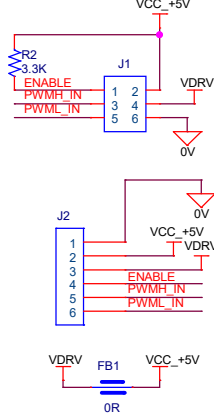

PROBE TEST POINT

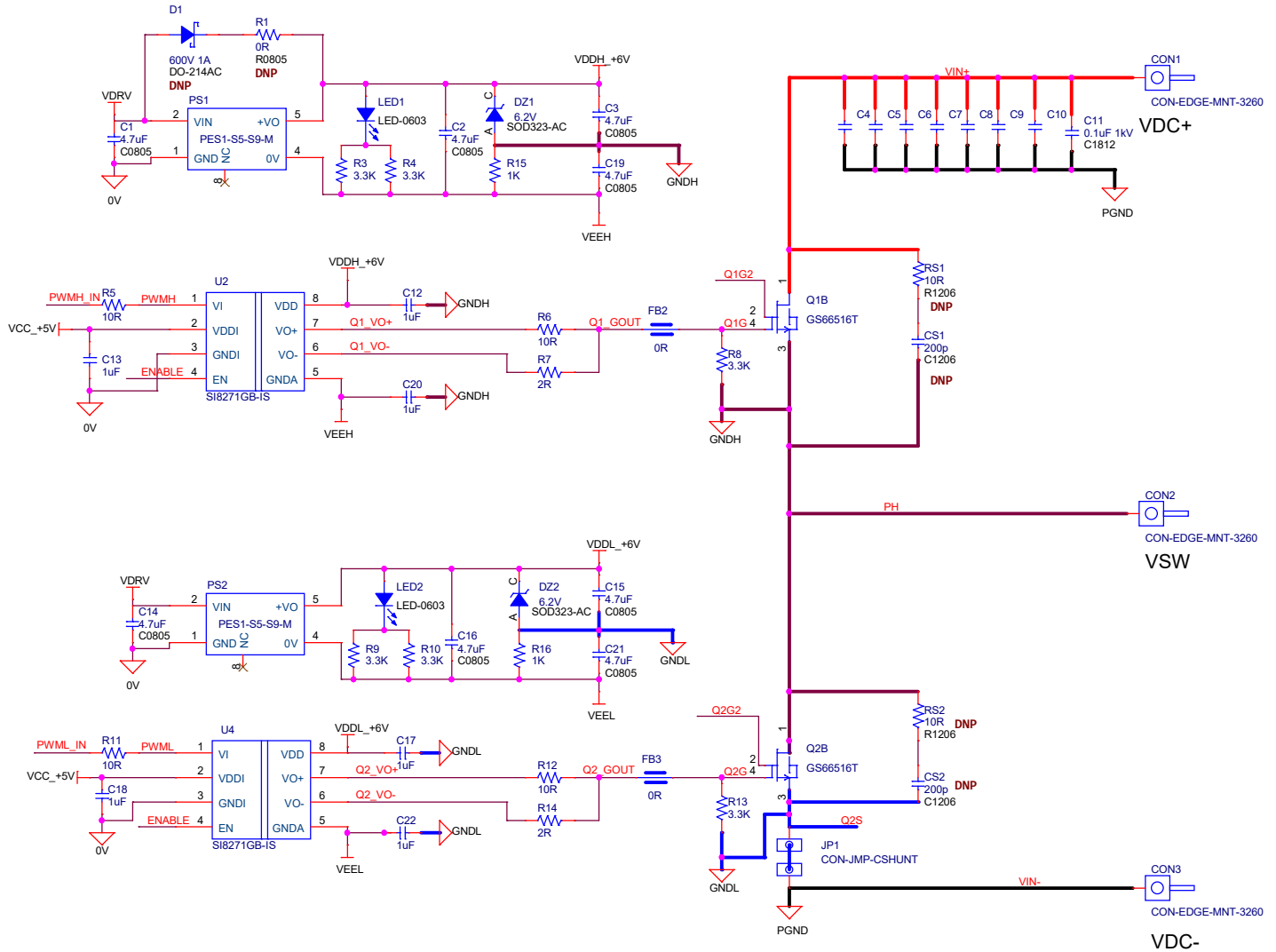
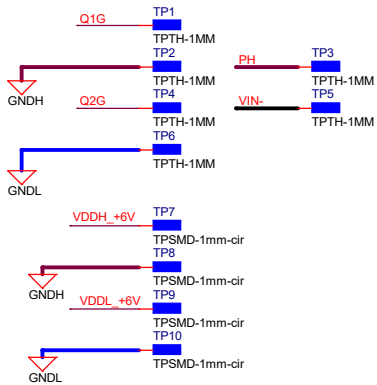

Title GS66516T HALF BRIDGE DAUGHTER CARD		
Sheet Description MAIN		
Document	Sheet 1 of 1	1145 Innovation Dr. Suite 101 Ottawa ON K2K 3G8 This document contains information proprietary to GaN Systems.
Date: Friday, January 26, 2018		